

Nippi

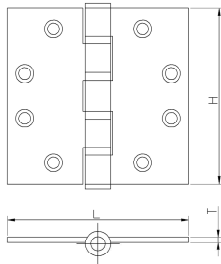

Satin Stainless Steel (SS) , with 2 Ball Bearings



BLISTER PACK as above is also available

PLAIN, WITHOUT BALL BEARING

Model No.	Dimension(H x L x T)
SS202020	2.0" x 2.0" x 2.0mm
SS252520	2.5" x 2.5" x 2.0mm
SS303020	3.0" x 3.0" x 2.0mm
SS353520	3.5" x 3.5" x 2.0mm
SS403020	4.0" x 3.0" x 2.0mm
SS404020	4.0" x 4.0" x 2.0mm
SS303025	3.0" x 3.0" x 2.5mm
SS353525	3.5" x 3.5" x 2.5mm
SS403025	4.0" x 3.0" x 2.5mm
SS404025	4.0" x 4.0" x 2.5mm
SS505025	5.0" x 5.0" x 2.5mm
SS353530	3.5" x 3.5" x 3.0mm
SS403030	4.0" x 3.0" x 3.0mm
SS404030	4.0" x 4.0" x 3.0mm
SS505030	5.0" x 5.0" X 3.0mm

WITH BALL BEARINGS

Model No.	Dimension(H x L x T)
SS303020 2BB	3.0" x 3.0" x 2.0mm
SS353520 2BB	3.5" x 3.5" x 2.0mm
SS403020 2BB	4.0" x 3.0" x 2.0mm
SS404020 2BB	4.0" x 4.0" x 2.0mm
SS303025 2BB	3.0" x 3.0" x 2.5mm
SS353525 2BB	3.5" x 3.5" x 2.5mm
SS403025 2BB	4.0" x 3.0" x 2.5mm
SS404025 2BB	4.0" x 4.0" x 2.5mm
SS505025 2BB	5.0" x 5.0" x 2.5mm
SS353530 2BB	3.5" x 3.5" x 3.0mm
SS403030 2BB	4.0" x 3.0" x 3.0mm
SS404030 2BB	4.0" x 4.0" x 3.0mm
SS505030 2BB	5.0" x 5.0" X 3.0mm

Above mentioned sizes and finishes are also available in "STEEL MATERIAL"



Satin Stainless Steel (SS)



Polished Stainless Steel (PSS)



Antique Brass (AB)



Antique Copper (AC)



Gold Plated (GP)



Dark Amber (10B)

Nippi



Polished and lacquered (P&L) with 2-Ball bearings

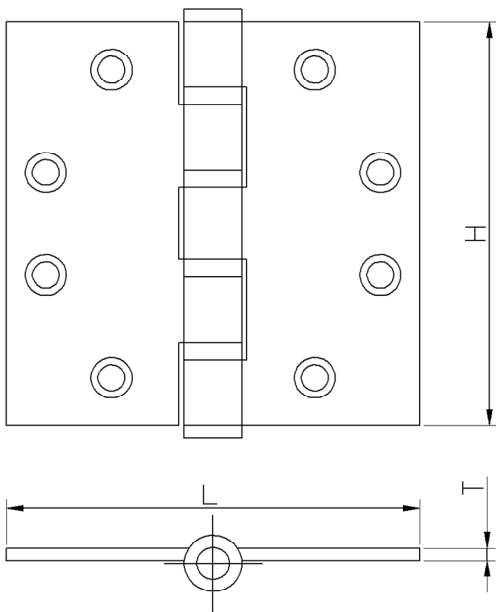

PLAIN, WITHOUT BEARING

Model No.	Dimension(H x L x T)
SB403020	4.0" x 3.0" x 2.0mm
SB403025	4.0" x 3.0" x 2.5mm
SB403028	4.0" x 3.0" x 2.8mm
SB403530	4.0" x 3.5" x 3.0mm
SB403030	4.0" x 3.0" x 3.0mm
SB404030	4.0" x 4.0" x 3.0mm

WITH 2-BALL BEARINGS

Model No.	Dimension(H x L x T)
SB403020 2-BB	4.0" x 3.0" x 2.0mm
SB403025 2-BB	4.0" x 3.0" x 2.5mm
SB403030 2-BB	4.0" x 3.0" x 3.0mm
SB404030 2-BB	4.0" x 4.0" x 3.0mm
SB454035 2-BB	4.5" x 4.0" x 3.5mm
SB454535 2-BB	4.5" x 4.5" x 3.5mm

WITH 4-BALL BEARINGS

Model No.	Dimension(H x L x T)
SB403020 4-BB	4.0" x 3.0" x 2.0mm
SB403025 4-BB	4.0" x 3.0" x 2.5mm
SB403030 4-BB	4.0" x 3.0" x 3.0mm
SB404030 4-BB	4.0" x 4.0" x 3.0mm
SB454035 4-BB	4.5" x 4.0" x 3.5mm
SB454535 4-BB	4.5" x 4.5" x 3.5mm

AVAILABLE FINISHES

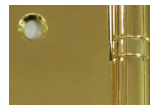

Polished and lacquered (P&L)



Satin Brass (SB)

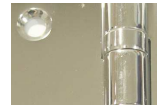

Chrome Plated (CP)



Antique Brass (AB)



Antique Copper (AC)

AVAILABLE TIPS



FT



AT



BT



CT



PT2



PT3



GT



ST



PT1



**"TOYO" BRAND GLASS OIL CUTTER,
METAL BODY**

COUNTRY OF ORIGIN : JAPAN

No TC-17B



**ZINC DIE CAST SLIDING DOOR LOCK
WITHOUT KEY**

COUNTRY OF ORIGIN : TAIWAN

A) WHITE COLOR

B) BLACK COLOR



**DEAD LOCK FOR ALUMINUM DOOR, WITH
DIE-CAST DOUBLE CYLINDER, 3-KEYS**

COUNTRY OF ORIGIN : TAIWAN

NO. 5128-W DEAD BOLT SILVER
NO. 5128-W DEAD BOLT BRONZE

NO. 4128-W HOOK BOLT SILVER
NO. 4128-W HOOK BOLT BRONZE
(TIPO "ADAM RITE")

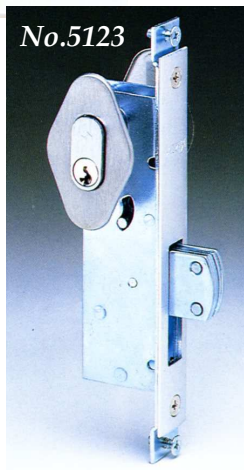

**DEAD LOCK FOR ALUMINUM DOOR, WITH
WITH BRASS DOUBLE CYLINDER, 3-KEYS**

COUNTRY OF ORIGIN : TAIWAN

NO. 4123 HOOK BOLT SILVER
NO. 4123 HOOK BOLT BRONZE

NO. 5123 DEAD BOLT SILVER
NO. 5123 DEAD BOLT BRONZE

UL 520 Series PANIC EXIT DEVICE

REVERSIBLE RIM TYPE
Conforming to ANSI standard A 156.3 Grade 1



UL520 PANIC EXIT DEVICE

SPECIFICATIONS:
For Doors 1-3/4" thick, Wood or Metal
(Specify thickness if other than 1-3/4")
Door widths from 30" - 48".

Hand Non-Handed.
Latchbolt Stainless Steel, 3/4" throw.
Dead Latch Stainless Steel, 5/8".
Strike For 5/8" Stop plus Shim for 1/2" stop.
Spring Stainless steel.
Chassis Steel or Stainless Steel.
Cover High density rust-resistant alloy.
Rail Assembly Steel or Stainless Steel.
End cap Steel or Stainless Steel.
Dogging Allen type dogging standard.
UL Listed PANIC HARDWARE, UL/CUL.
Finishes USP- Alum/Duro/Bronze,
US3, US26D, US32D

UL520V VERTICAL ROD PANIC EXIT DEVICE

SPECIFICATIONS:
For Doors 1-3/4" thick, Wood or Metal
(Specify thickness if other than 1-3/4")
Door widths from 30" - 48" &
Door height up to 96"

Hand Field Reversible.
Latchbolt SSS Top latch, Steel Bottom bolt.
Strike TS320V for Top & BS520V for Bottom.
Spring Stainless steel.
Chassis Steel, Stainless Steel or Brass.
Cover High density rust-resistant alloy.
Rail Assembly Steel or Stainless Steel.
End cap Steel or Stainless Steel.
UL Listed PANIC HARDWARE, UL/CUL
Finishes USP- Alum/Duro/Bronze,
US3, US26D, US32D



UL 620 Series FIRE EXIT DEVICE

REVERSIBLE RIM TYPE
Conforming to ANSI standard A 156.3 Grade 1



UL620 FIRE EXIT DEVICE

SPECIFICATIONS:
For Doors 1-3/4" thick, Wood or Metal
(Specify thickness if other than 1-3/4")
Door widths from 30" - 48".

Hand Non-Handed.
Latchbolt Stainless Steel, 3/4" throw.
Dead Latch Stainless Steel, 5/8".
Strike DS620, SSS
Spring Stainless steel.
Chassis Steel or Stainless Steel.
Cover High density rust-resistant alloy.
Rail Assembly Steel or Stainless Steel.
End cap Steel or Stainless Steel.
UL Listed FIRE EXIT HARDWARE, UL/CUL.
Finishes USP- Alum/Duro/Bronze,
US3, US26D, US32D

UL620V VERTICAL ROD FIRE EXIT DEVICE

SPECIFICATIONS:
For Doors 1-3/4" thick, Wood or Metal
(Specify thickness if other than 1-3/4")
Door widths from 30" - 48" &
Door height up to 96"

Hand Field Reversible.
Latchbolt SSS Top latch, Steel Bottom bolt.
Strike TS320V for Top & BS520V for Bottom.
Spring Stainless steel.
Chassis Steel, Stainless Steel or Brass.
Cover High density rust-resistant alloy.
Rail Assembly Steel or Stainless Steel.
End cap Steel or Stainless Steel.
UL Listed FIRE EXIT HARDWARE, UL/CUL
Finishes USP- Alum/Duro/Bronze,
US3, US26D, US32D

AFL620 Aux fire latch assy
THE AUX FIRE LATCH ASSY BEING USED WITH VERTICAL ROD EXIT DEVICE NO BOTTOM UNIT IS TO KEEP FIRE DOORS IN ALIGNMENT DURING A FIRE.



"UL" LISTED

PANIC EXIT DEVICE, EXIT ONLY

NO. UL-520	900mm	ALUM
NO. UL-520	1200mm	ALUM
NO. UL-520	900mm	ST. STEEL
NO. UL-520	1200mm	ST. STEEL

PANIC EXIT DEVICE, WITH VERTICAL ROD

NO. UL-520V	900mm	ALUM
NO. UL-520V	1200mm	ALUM
NO. UL-520V	900mm	ST. STEEL
NO. UL-520V	1200mm	ST. STEEL

"UL" LISTED & 3 HOUR FIRE RATED

PANIC EXIT DEVICE, EXIT ONLY

NO. UL-620	900mm	ALUM
NO. UL-620	1200mm	ALUM
NO. UL-620	900mm	ST. STEEL
NO. UL-620	1200mm	ST. STEEL

PANIC EXIT DEVICE, WITH VERTICAL ROD

NO. UL-620V	900mm	ALUM
NO. UL-620V	1200mm	ALUM
NO. UL-620V	900mm	ST. STEEL
NO. UL-620V	1200mm	ST. STEEL

Finishes - All Plate Trim in US32D Painted, US3, US26D offering upon order specified.
All Plate Trim is furnished LHR & without Cylinder, unless order specified.
All Plate Trim is changeable Handed- LH/RH without dissolved except TP620/NTP620.

TRIM & PLATE for UL520&620series

	SC4, 6 Pins, US26D, US3		PP520 Plain Pull Plate Painted Alum, US32D
	SC4, 6 Pins, US32D, US3		PC520 Cylinder Pull Plate Painted Alum, US32D
	MC620 Mortise Cylinder 1", SC4, 6 Pins, US32D		RC520 Rim Cylinder SC1, 5 Pins, US26D SC4, 6 Pins, US26D/US3

APPLICATIONS:



Single Door with Rim Device
Single Door with Vertical Device
Pair of Doors with Rim Device and Vertical Device
Pair of Doors with two Vertical Devices
Pair of Doors with two Rim Devices and Mullion

コンクリート釘

[標準梱包] 500g/小箱, 50箱/カートン



光沢メッキ

スムーズシャンク: #12
フルートシャンク: #10/9/8/7

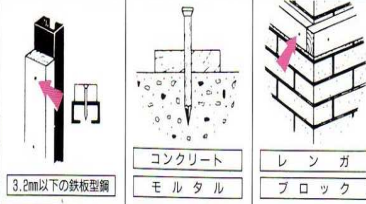

3.2mm以下の鉄板型鋼

コンクリート
モルタル
レンガ
ブロック

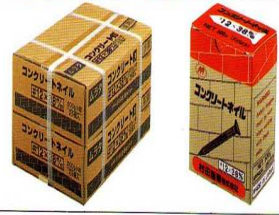

サイズ	1本の重量	500g当りの本数
#12× 25mm	1.28g	約390本
12× 38	1.92	260本
12× 50	2.50	200本
10× 50	4.31	116本
10× 65	5.88	85本
10× 75	6.33	79本
9× 25	2.50	200本
9× 38	3.85	130本
9× 50	5.00	100本
8× 65	8.33	60本
7× 75	11.11	45本
7× 90	12.50	40本
7×100	14.29	35本

【ご注意】

- ヒューム管、石材等にはご使用できません。
- お使いになる際は、なるべく重いハンマーをご使用ください。又、防護メガネをご使用ください。

※500g/小箱25ヶ入 2箱梱包

"MURATA" BRAND CONCRETE NAILS, BRIGHT FINISH

SIZES:

BWG

#9 X	25MM
	38MM
	50MM
#7 X	65MM
	75MM
	90MM
	100MM

"WHALE" Brand Steel Belt Lacings.

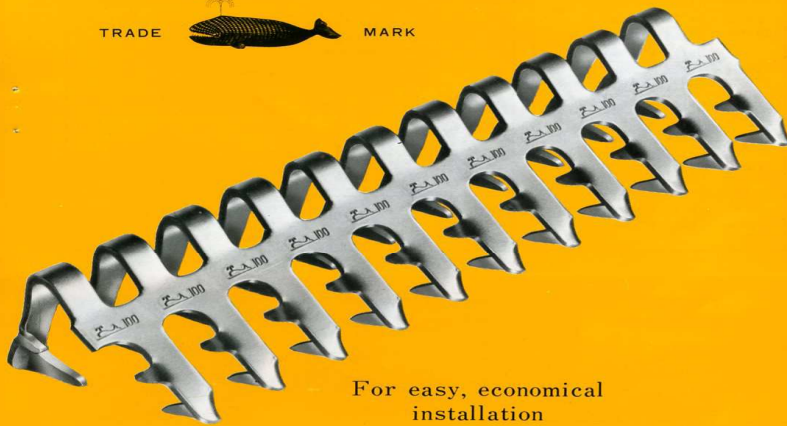

For easy, economical
installation
and
especially smooth joints
on
Transmission or Conveyer
Belts.

THE WHALE BELT LACING CO.,LTD.

"WHALE" BRAND BELT LACING

NUMBER	SET No.	box/cart.
#15	8	50
#20	7-1/2	50
#25F	6	50
#25G	8	30
#27L	8	20
#35M	4	50
#35N	4	30
#45U	4	20
#55W	4	15
#65X	4	15
#75	4	8



Above photos show Stainless Steel, Hair Line finish, 6" & 12"

AVAILABLE MATERIALS & FINISHES

SIZE : 6"

REF:	FB-150-SS	(St. Steel, HAIR LINE FINISH)
	FB-150-PB	(Brass, POLISHED BRASS FINISH)
	FB-150-AB	(St. Steel, ANTIQUE BRASS FINISH)
	FB-150-AC	(St. Steel, ANTIQUE COPPER FINISH)

SIZE : 12"

REF:	FB-300-SS	(ST. STEEL, HAIR LINE FINISH)
	FB-300-PB	(Brass, POLISHED BRASS FINISH)
	FB-300-AB	(St. Steel, ANTIQUE BRASS FINISH)
	FB-300-AC	(St. Steel, ANTIQUE COPPER FINISH)

CYLINDRICAL KNOB LOCKSETS, "BALL" KNOB CERRADURA CILINDRICA, POMO "BOLA"

CYLINDRICAL KNOB LOCK

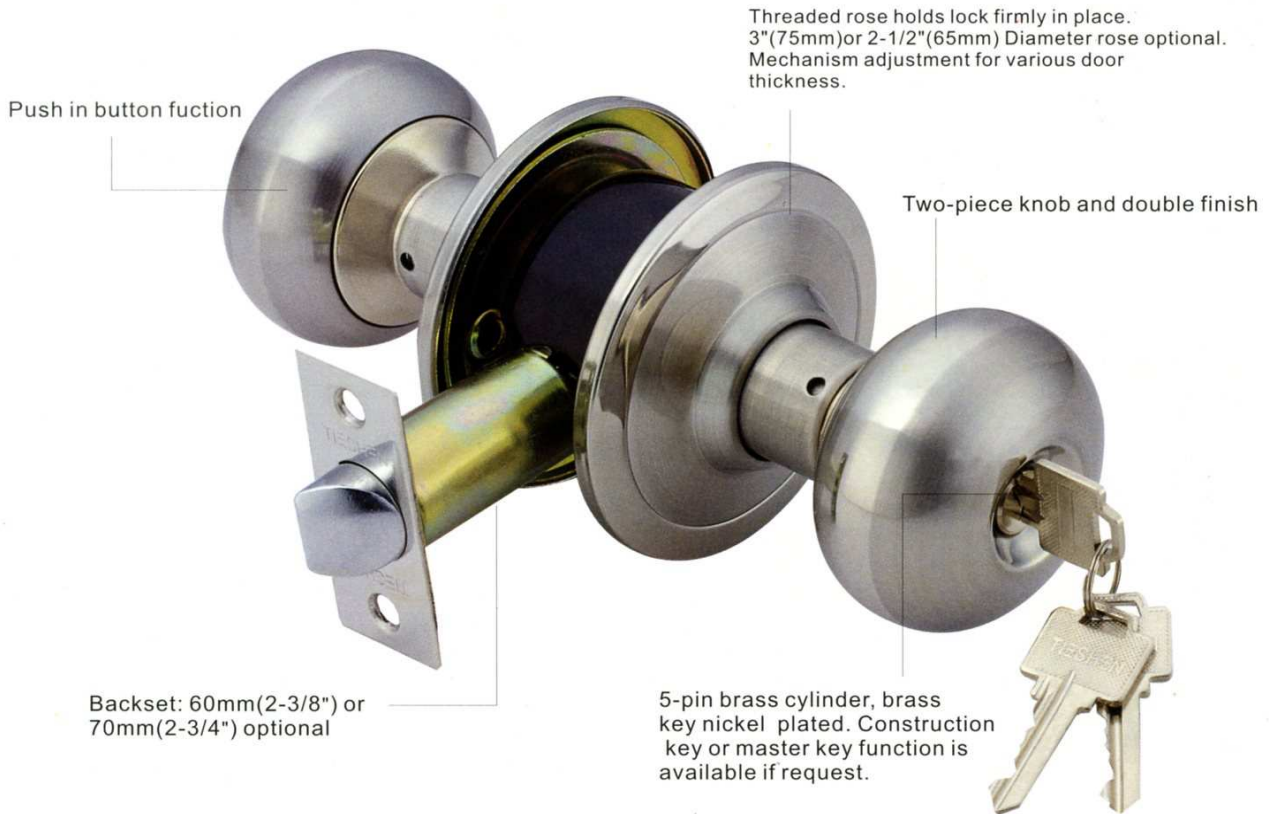

A691g SS-XL

Knob styles and finishes available



AUXILIARY DEADBOLT LOCKSETS CERRADURA AUXILIAR

RESIDENTIAL DEADBOLT LOCK

Single deadbolt

Zinc alloy adjustable
deadbolt latch backset:
60mm(2-3/8") or 70mm(2-3/4")

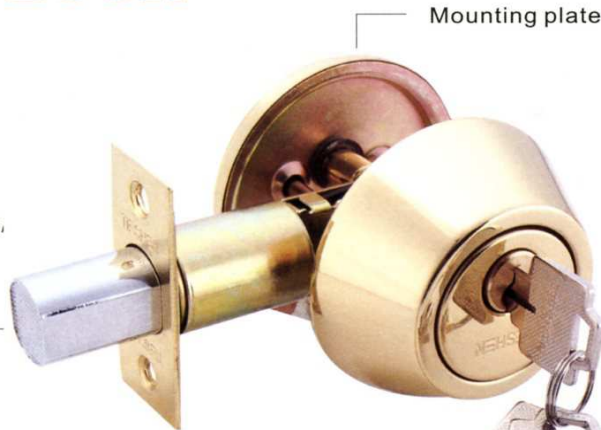

Brass or Stainless steel housing

5-Pin brass cylinder, matched
with brass keys. Construction
key or master key function is
available if request.

Double deadbolt

Zinc alloy adjustable
deadbolt latch backset:
60mm(2-3/8") or 70mm(2-3/4")



Brass or Stainless steel housing

5-Pin brass cylinder, matched
with brass keys. Construction
key or master key function is
available if request.

C312SS

Half deadbolt

Zinc alloy adjustable
deadbolt latch backset:
60mm(2-3/8") or 70mm(2-3/4")



CY301AC

TUBULAR LOCKSETS CERRADURA TUBULAR

TUBULAR KNOB LOCK

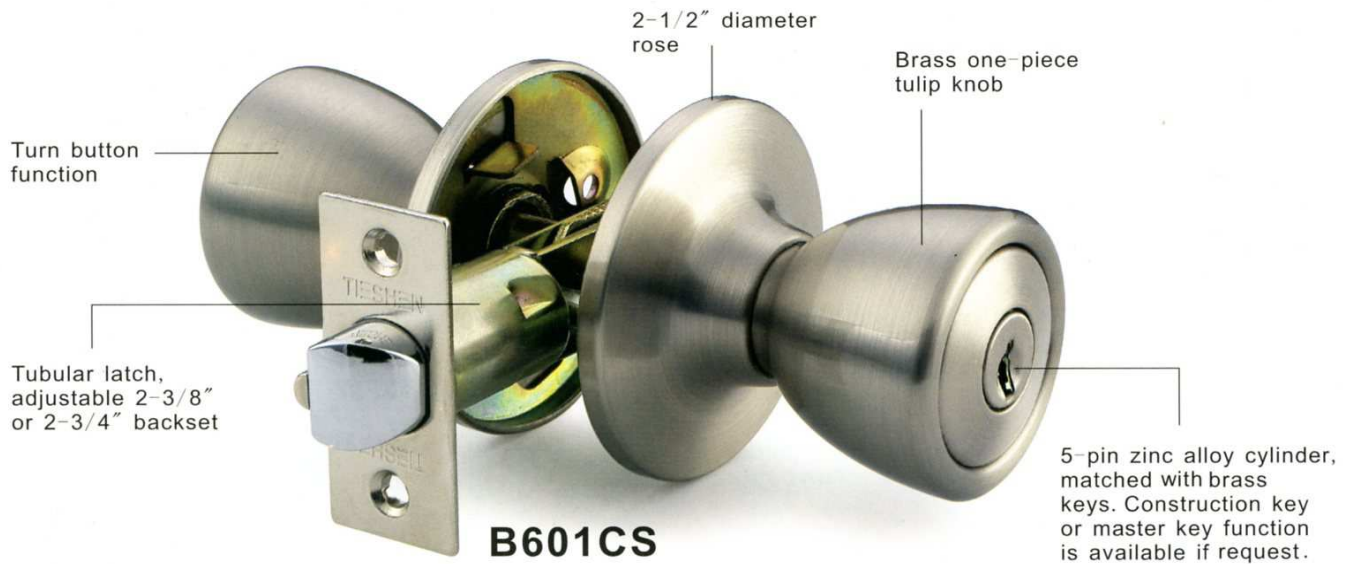

HEAVY DUTY CYLINDRICAL LEVER LOCK CERRADURA CILINDRICA DE MANIJA, TIPO PESADA

HEAVY DUTY CYLINDRICAL LEVER LOCK

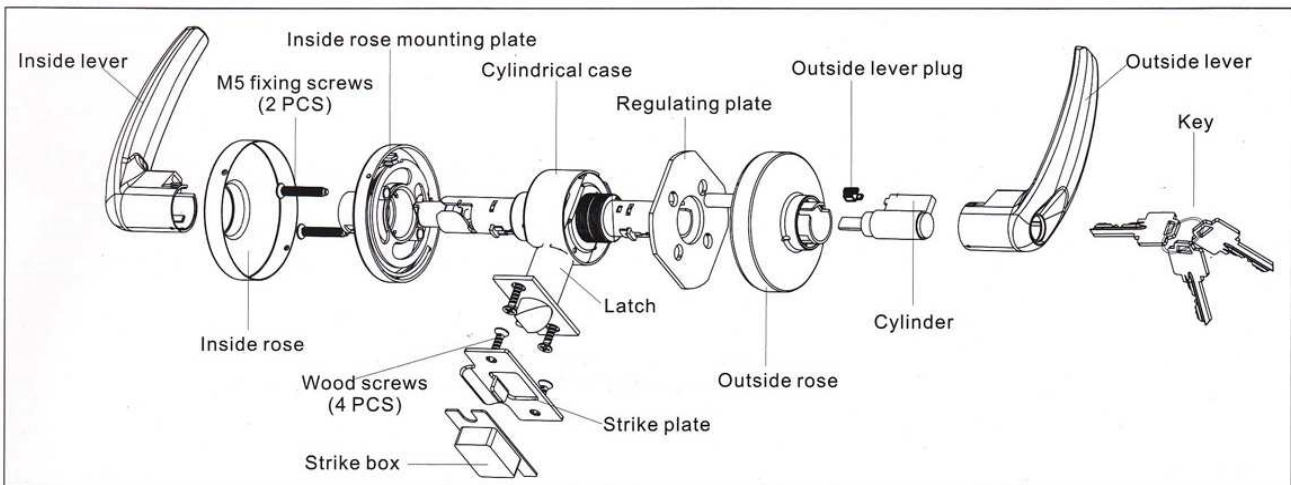
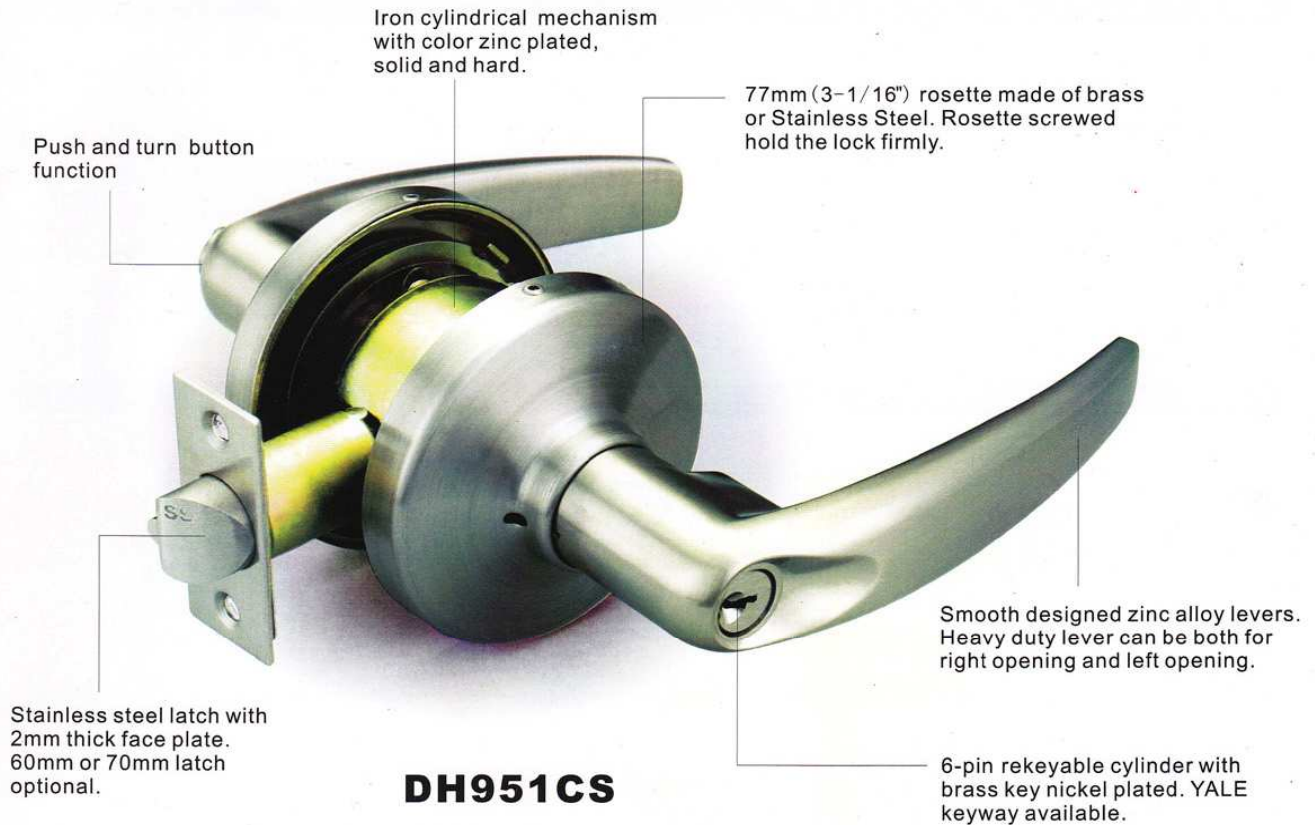

<http://www.tieshen.com>

HEAVY DUTY CYLINDRICAL LEVER LOCK CERRADURA CILINDRICA DE MANIJA, TIPO PESADA

FINISHES AVAILABLE

FINISH CODE	US CODE	DESCRIPTION
PB	US 3	Polished Brass
SB	US 4	Satin Brass
AB	US 5	Antique Brass
AC	US 11	Antique Copper
SS	US 32D	Satin Stainless Steel
SP	US 32	Polished Stainless Steel
CS	US 15	Satin Nickel
SC	US 26D	Satin Chrome
CR	US 26	Bright Chrome
AD	US 15A	Antique Nickel
10B	US 10B	Oil Rubbed Bronze
PVD		Antique Golden Lifetime Finish

SPECIFICATION

Backset:	Optional 2-3/8" or 2-3/4"(60mm or 70mm)
Door thickness:	Adjustable from 1-1/4"-2"(32mm-50mm)
Cylinder:	6-pin cylinder, Kwikset and Yale keyway are available
Face plate:	1"X2-1/4"(25.4mmX57mm) square corner standard, Round corner optional
Strike plate:	1-9/16"X2-3/4"(40mmX70mm) round corner
Door opening direction:	Fit for both right and left hand door

DIMENSIONS

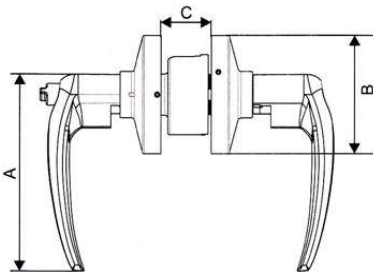

Issue	Item No.	DH951
	A	5-1/16"
	B	3-1/16"
	C	1-1/4"-2"

FUNCTION DESCRIPTIONS

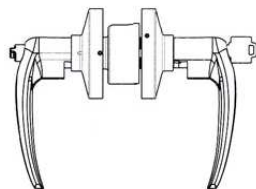

Entry / Office Lock

Pushing button locks outside lever until unlocked by key or inside lever is turned.
Turn/push button locking. Pushing and turning button locks outside lever forever even using a key until button is manually turned back. The inside lever is always unlocked providing emergency exit.

DH951

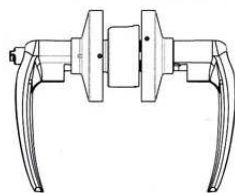

Privacy lock

Latch operated by lever from either side. Outside lever is locked by pushing button inside and unlocked by emergency release outside, or rotating inside lever.

DH952

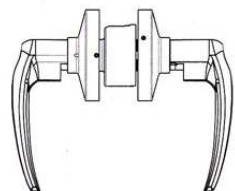

Passage / Closets

Both levers are always unlocked inside and outside.

DH953

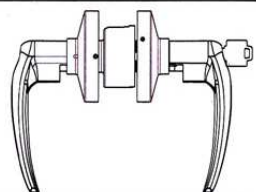

Store room / hotel room lock

Outside lever is only unlocked by key, inside lever is always free.

DH954